

Linear actuators ATL Series and BSA Series

2.7 ORDERING CODE

ATL	30	RN2	C300	FO	—	FCE	Vers. 3	RH
1	2	3	4	5	6	7	8.A	8.B

SP	FS
9	

AC 3-phase brake-motor	0.18 kW	4-pole	230/400 V	50 Hz	IP 55	Ins. F	W
10.A							10.B

1	Actuator series ATL or BSA	
2	Actuator size 20, 25, 28, 30, 40, 50, 63, 80, 100, 125	pages 42 ... 45
3	Ratio RH1, RV1, RN1, RL1, RXL1 RH2, RV2, RN2, RL2, RXL2	pages 42 ... 45
4	Stroke code C100, C200, C300, C400, C500, C600, C700, C800 (special stroke available on request)	
5	Front attachment BA - standard head with threaded bore ROE - rod end FO - clevis end TS - ball joint FL - flange end TF - hinged head	pages 54 ... 81
6	Position of front and rear actuator attachment STANDARD (without code) or RPT 90°	page 82
7	Stroke end switches FCE - electric stroke length limit device FC - electric switches FCM-NC - magnetic reed switches, normally closed FCM-NO - magnetic reed switches normally open FCP - inductive proximity switches	page 88 page 89 page 90 page 90 page 92
8.A	Actuator input Vers.1 - single input shaft Vers.2 - double input shaft Vers.3 - attachment for IEC motor (flange and hollow shaft) Vers.4 - attachment for IEC motor (flange and hollow shaft) + second shaft Vers.5 - attachment for IEC motor (adapter and coupling) Vers.6 - attachment for IEC motor (adapter and coupling) + second shaft	pages 83 ... 87
8.B	Motor mounting side - main input drive side RH (standard) or LH	page 82
9	Accessories SP - rear bracket FI - intermediate support flange AR - anti-turn device FS - safety clutch MS - safety nut for push load B - bellows encoder - EH 53 or ENC.4 or GI.2X or according to required specifications	pages 54 ... 81 page 82 page 93 page 93 page 94 page 94 pages 95 ... 96
10.A	Motor data	pages 200 ... 201
10.B	Motor terminal box position	page 82
11	Other specifications example: push rod in stainless steel AISI 304 example: lubricant for low temperature	
12	Filled in SELECTION DATA sheet	page 98 ... 99
13	Application layout	

APPLICATION: _____

REQUIRED STROKE: _____ mm

REQUIRED LINEAR SPEED: _____ mm/s _____ mm/min _____ m/min TIME TO PERFORM 1 STROKE: _____ s

STATIC LOAD: PULL: _____ N PUSH: _____ N at STROKE _____ mm

DYNAMIC LOAD: PULL: _____ N PUSH: _____ N at STROKE _____ mm

ACTUATOR SUBJECTED TO VIBRATIONS NOT SUBJECTED TO VIBRATIONS

OPERATING: _____ cycle / hour _____ working hours / day Notes: _____

REQUIRED LIFETIME: _____ cycle _____ hours _____ calendar days Notes: _____

ENVIRONMENT: TEMPERATURE _____ °C DUST HUMIDITY _____ % AGGRESSIVE AGENT _____

Acme screw actuators **ATL Series**

Ball screw actuators **BSA Series**

Size: 20 25 28 30 40

Ratio: RH2 RH1 RV2 RV1 RN2 RN1 RL2 RL1 RXL2 RXL1

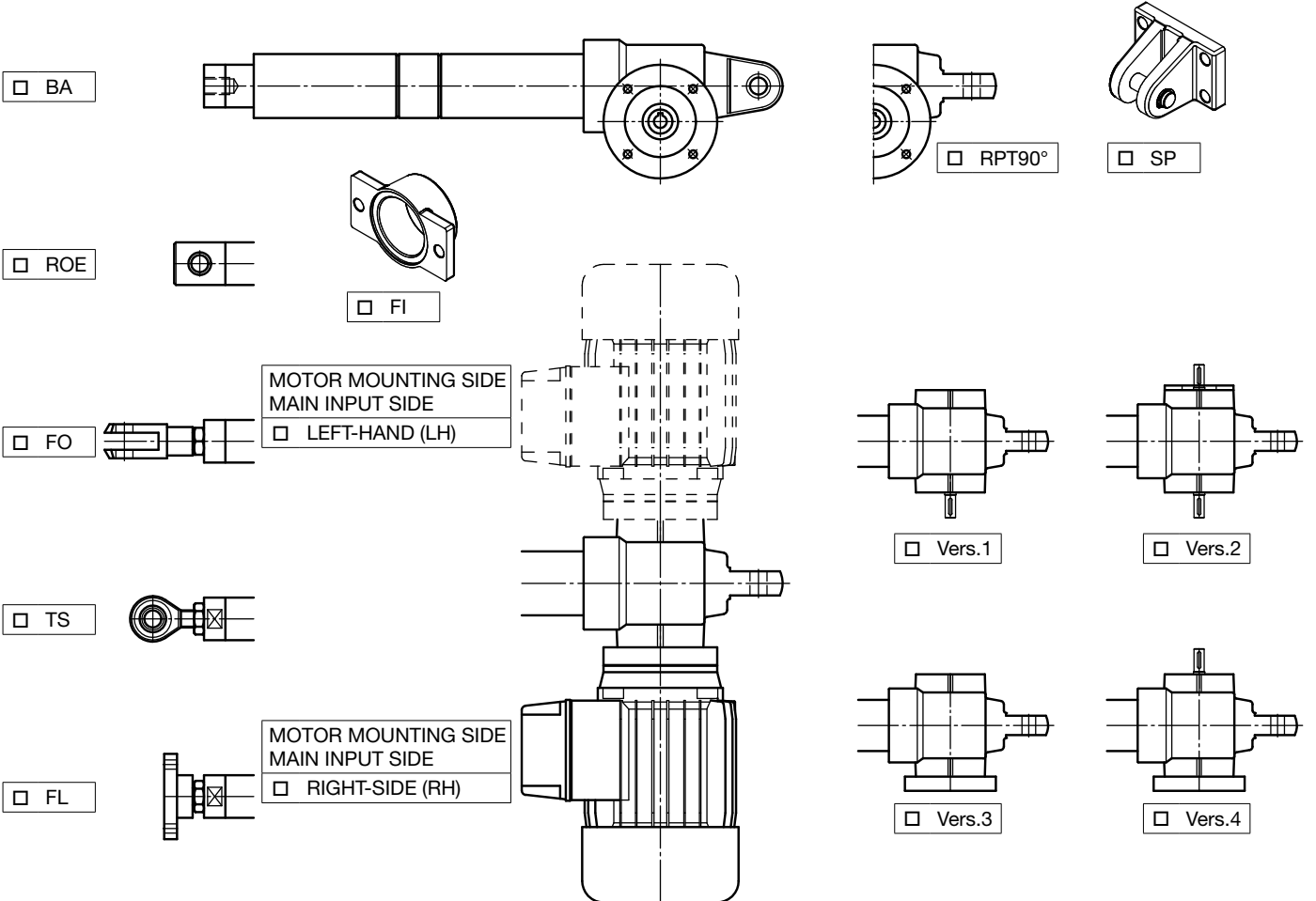

ELECTRIC MOTOR AC 3-phase AC 1-phase DC 24 V or 12 V WITHOUT BRAKE WITH BRAKE

STROKE END SWITCHES ELECTRIC FCE MAGNETIC FCM PROXIMITY FCP

ANTI-TURN DEVICE AR SAFETY CLUTCH FS SAFETY NUT MS

BELLOWS PUSH ROD IN STAINLESS STEEL OUTER TUBE IN STAINLESS STEEL

POSITIONING CONTROL WITH ROTARY ENCODER LINEAR TRANSDUCER

OTHER: _____

APPLICATION: _____

REQUIRED STROKE: _____ mm

REQUIRED LINEAR SPEED: _____ mm/s _____ mm/min _____ m/min TIME TO PERFORM 1 STROKE: _____ s

STATIC LOAD: PULL: _____ N PUSH: _____ N at STROKE _____ mm

DYNAMIC LOAD: PULL: _____ N PUSH: _____ N at STROKE _____ mm

ACTUATOR SUBJECTED TO VIBRATIONS NOT SUBJECTED TO VIBRATIONS

OPERATING: _____ cycle / hour _____ working hours / day Notes: _____

REQUIRED LIFETIME: _____ cycle _____ hours _____ calendar days Notes: _____

ENVIRONMENT: TEMPERATURE _____ °C DUST HUMIDITY _____ % AGGRESSIVE AGENT _____

Acme screw actuators **ATL Series**

Ball screw actuators **BSA Series**

Size: 50 63 80 100 125

Ratio: RV2 RV1 RN2 RN1 RL2 RL1 RXL2 RXL1

BA

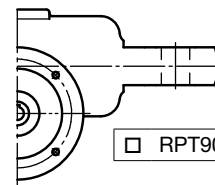
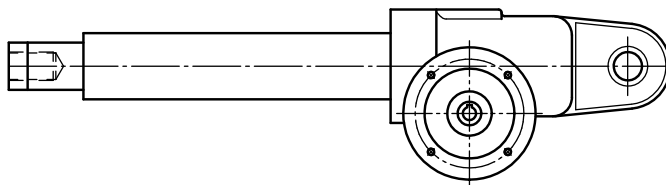

RPT90°

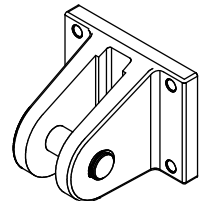

SP

TF



MOTOR MOUNTING SIDE
 MAIN INPUT SIDE
 LEFT-HAND (LH)

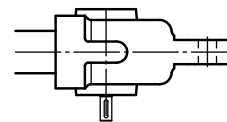
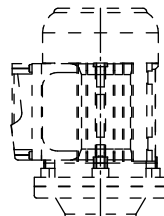

Vers.1

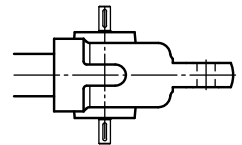

Vers.2

TS

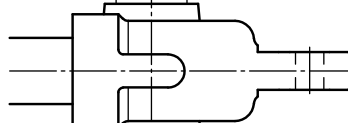
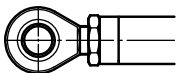

Vers.3

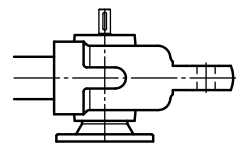

Vers.4

FL

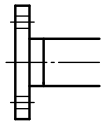

MOTOR MOUNTING SIDE
 MAIN INPUT SIDE
 RIGHT-SIDE (RH)

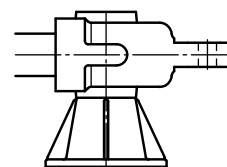
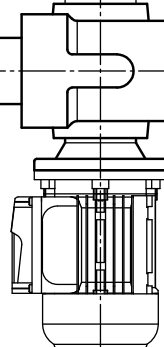

Vers.5

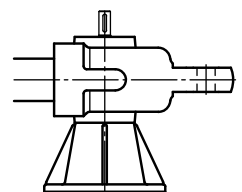

Vers.6

ELECTRIC MOTOR AC 3-phase _____ WITHOUT BRAKE WITH BRAKE

STROKE END SWITCHES ELECTRIC FCE PROXIMITY FCP ELECTRIC FC

ANTI-TURN DEVICE AR SAFETY CLUTCH FS SAFETY NUT MS

BELLOWS PUSH ROD IN STAINLESS STEEL OUTER TUBE IN STAINLESS STEEL

POSITIONING CONTROL WITH ROTARY ENCODER LINEAR TRANSDUCER

OTHER: _____